

# JVC

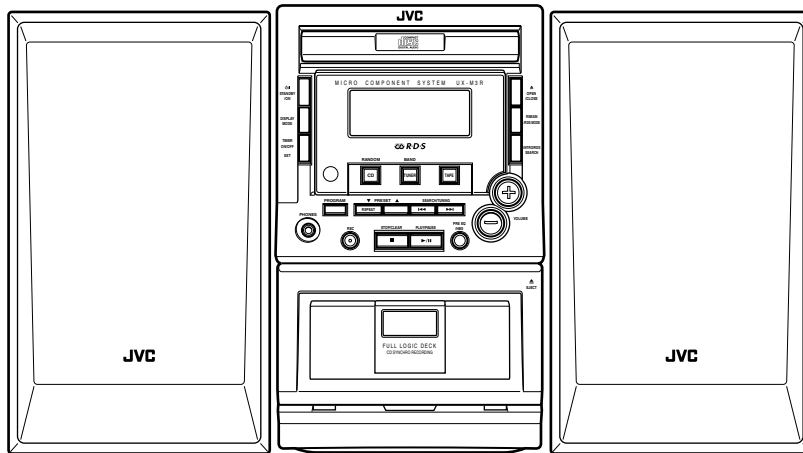
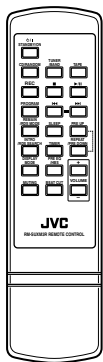

## MICRO COMPONENT SYSTEM

# UX-M3R

 — Consists of CA-UXM3R and SP-UXM3.

COMPACT  
**disc**  
DIGITAL AUDIO



## INSTRUCTIONS

**For Customer Use:**

Enter below the Model No. and Serial No. which are located either on the rear, bottom or side of the cabinet. Retain this information for future reference.

Model No. \_\_\_\_\_

Serial No. \_\_\_\_\_

# Warnings, Cautions and Others

## Caution — STANDBY/ON button!

Disconnect the mains plug to shut the power off completely. The STANDBY/ON  button in any position does not disconnect the mains line. The power can be remote controlled.

### CAUTION

To reduce the risk of electrical shocks, fire, etc.:

1. Do not remove screws, covers or cabinet.
2. Do not expose this appliance to rain or moisture.

### CAUTION

- Do not block the ventilation openings or holes.  
(If the ventilation openings or holes are blocked by a newspaper or cloth, etc., the heat may not be able to get out.)
- Do not place any naked flame sources, such as lighted candles, on the apparatus.
- When discarding batteries, environmental problems must be considered and local rules or laws governing the disposal of these batteries must be followed strictly.
- Do not expose this apparatus to rain, moisture, dripping or splashing and that no objects filled with liquids, such as vases, shall be placed on the apparatus.

## IMPORTANT FOR LASER PRODUCTS

### REPRODUCTION OF LABELS

- ① CLASSIFICATION LABEL, PLACED ON REAR ENCLOSURE

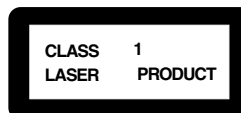

- ② WARNING LABEL, PLACED INSIDE THE UNIT

DANGER-Invisible laser radiation when open and interlock defeated. AVOID DIRECT EXPOSURE TO BEAM.	VARO! Avattaessa ja suojauslaitus ohitettaessa olet alttiina nädkmätön läasersatellylle. Älä katso säteeseen.
VORSICHT-Unsichtbare Laserstrahlung, wenn Abdeckung geöffnet und Sicherheitsverriegelung überbrückt. Nicht dem Strahl aussetzen.	VARNING! Osymtlig laserstrålning när denna del är ösppad och spärren är urkopplad. Beträka ej strålen.
ADVARSEL-USYNLIG LÅSERSTRÅLING VED ÅBNING, NÅR SIKKERHEDSAF-BRYDERE ER UDE AF FUNKTION. UNDGÅ UDSÆTTELSE FOR STRÅLING.	ADVERSEL! Usymtlig laserstrålning når deksel åpnes og sikkerhetslås brytes. Unngå eksponering for strålen. A pleine puissance, l'ecoute prolongee du baladeur peut endommager l'oreille de l'utilisateur.

1. CLASS 1 LASER PRODUCT
2. **DANGER:** Invisible laser radiation when open and interlock failed or defeated. Avoid direct exposure to beam.
3. **CAUTION:** Do not open the top cover. There are no user serviceable parts inside the Unit; leave all servicing to qualified service personnel.

**Caution: Proper Ventilation**

To avoid risk of electric shock and fire, and to prevent damage, locate the apparatus as follows:

1 Front:

No obstructions and open spacing.

2 Sides/ Top/ Back:

No obstructions should be placed in the areas shown by the dimensions below.

3 Bottom:

Place on the level surface. Maintain an adequate air path for ventilation by placing on a stand with a height of 10 cm or more.

Front view

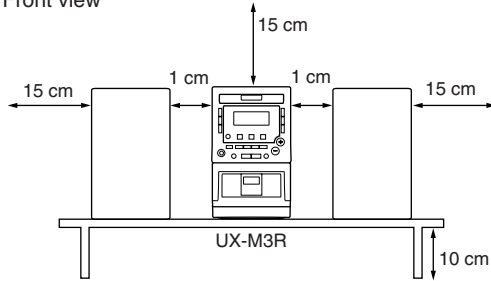

Side view

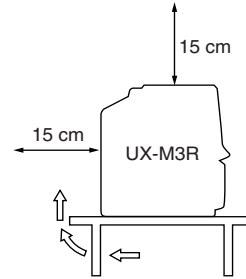

# Introduction

---

We would like to thank you for purchasing one of our JVC products. Before operating this unit, read this manual carefully and thoroughly to obtain the best possible performance from your unit, and retain this manual for future reference.

## About This Manual

---

This manual is organized as follows:

- The manual mainly explains operations using the buttons and controls on the unit. You can also use the buttons on the remote control if they have the same or similar names (or marks) as those on the unit. If operation using the remote control is different from that using the unit, it is then explained.
- Basic and common information that is the same for many functions is grouped in one place, and is not repeated in each procedure. For instance, we do not repeat the information about turning on/off the unit, setting the volume, changing the sound effects, and others, which are explained in the section “Common Operations” on pages 8 and 9.
- The following marks are used in this manual:



Gives you warnings and cautions to prevent a damage or risk of fire/electric shock. Also gives you information on operation which is not good for obtaining the best possible performance from the unit.



Gives you information and hints you had better know.

## Precautions

---

### Installation

- Install in a place which is level, dry and neither too hot nor too cold — between 5°C and 35°C.
- Install the unit in a location with adequate ventilation to prevent internal heat built-up in the unit.
- Leave sufficient distance between the unit and the TV.
- Keep the speakers away from the TV to avoid interference with TV.



DO NOT install the unit in a location near heat sources, or in a place subject to direct sunlight, excessive dust or vibration.

### Power sources

- When unplugging from the wall outlet, always pull the plug, not the AC power cord.



DO NOT handle the AC power cord with wet hands.

### Moisture condensation

Moisture may condense on the lens inside the unit in the following cases:

- After starting heating in the room
  - In a damp room
  - If the unit is brought directly from a cold to a warm place
- Should this occur, the unit may malfunction. In this case, leave the unit turned on for a few hours until the moisture evaporates, unplug the AC power cord, and then plug it in again.

### Others

- Should any metallic object or liquid fall into the unit, unplug the unit and consult your dealer before operating any further.
- If you are not going to operate the unit for an extended period of time, unplug the AC power cord from the wall outlet.



DO NOT disassemble the unit since there are no user serviceable parts inside.

If anything goes wrong, unplug the AC power cord and consult your dealer.

# Contents

---

<b>Location of the Buttons and Controls .....</b>	<b>3</b>
Front Panel .....	4
Remote Control .....	5
<b>Getting Started .....</b>	<b>6</b>
Unpacking .....	6
Putting the Batteries into the Remote Control .....	6
Connections .....	6
<b>Common Operations .....</b>	<b>8</b>
Turning On or Off the Unit .....	8
Setting the Clock .....	8
Adjusting the Volume .....	8
Digital Sound Control .....	9
<b>Listening to FM and MW Broadcasts .....</b>	<b>10</b>
Tuning In a Station .....	10
Presetting Stations .....	10
Tuning In a Preset Station .....	11
<b>Receiving FM Stations with RDS.....</b>	<b>12</b>
Changing the RDS Information .....	12
Searching for Programs by PTY Codes (PTY Search) .....	12
<b>Playing Back CDs .....</b>	<b>13</b>
Loading a Disc .....	13
Basic CD Operations .....	13
Program Play .....	13
Random Play .....	14
Repeat Play .....	14
Introductory Play .....	14
Displaying the Remaining Time during Playback ..	14
<b>Playing Back Tapes .....</b>	<b>15</b>
Loading a Tape .....	15
Tape Playback .....	15
Rewind/Fast Forward .....	15
<b>Recording .....</b>	<b>16</b>
Recording Tapes .....	16
<b>Using the Timers.....</b>	<b>17</b>
Using Daily Timer .....	17
Timer Recording .....	17
Using Sleep Timer .....	18
<b>Description of the PTY Codes .....</b>	<b>19</b>
<b>Troubleshooting .....</b>	<b>19</b>
<b>Maintenance .....</b>	<b>20</b>
<b>Specifications .....</b>	<b>Back cover</b>

# Location of the Buttons and Controls

Become familiar with the buttons and controls on your unit.



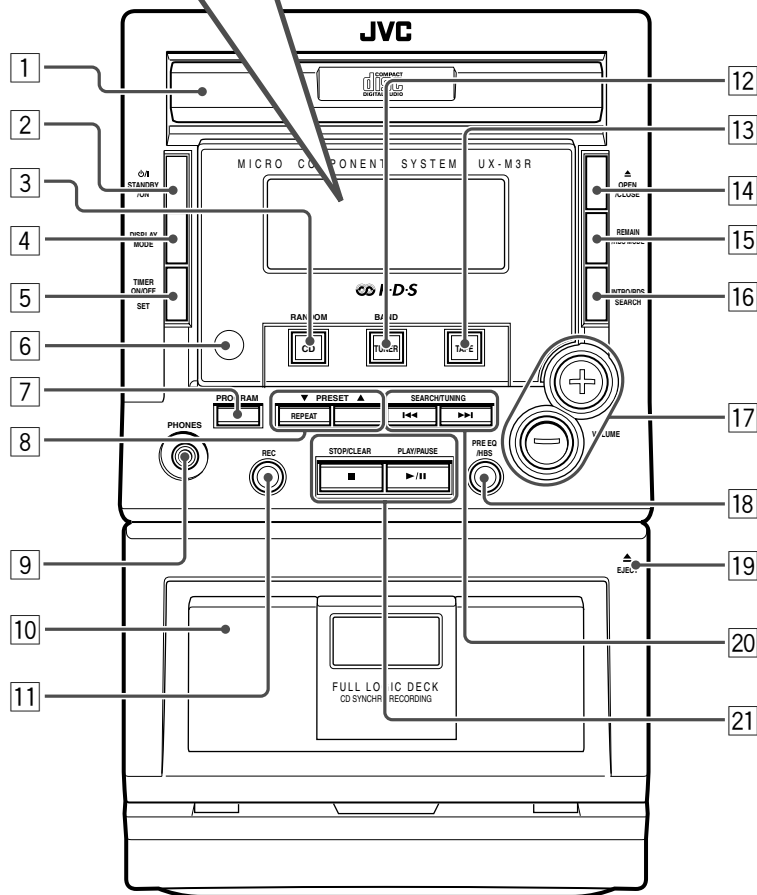
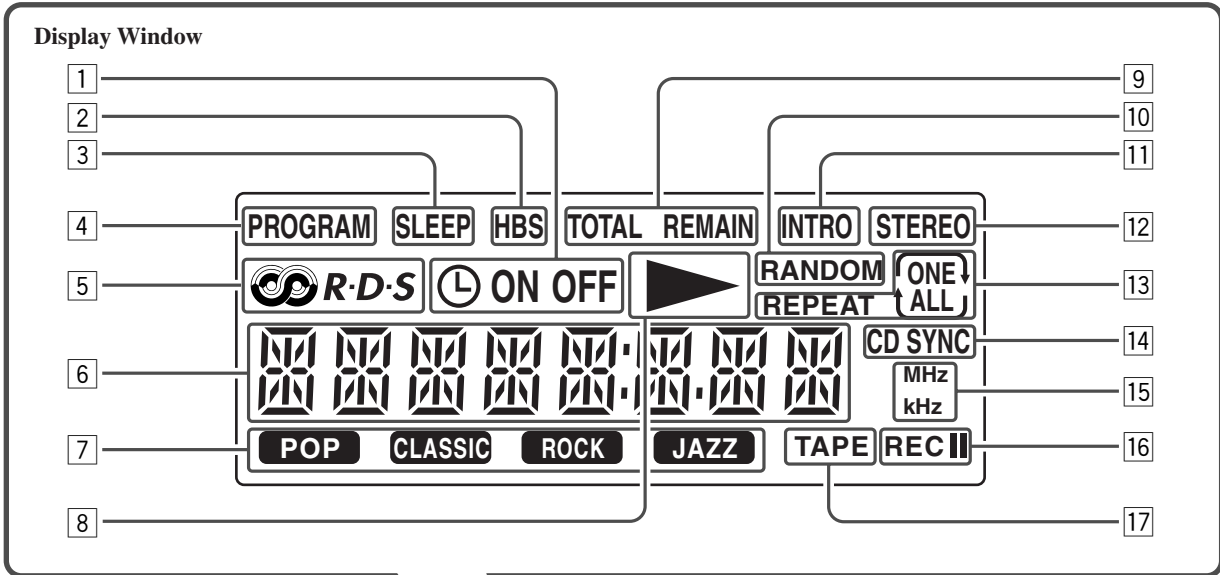





## Front Panel





## Front Panel



---

See pages in the parentheses for details.

- 1 Disc compartment (13)
- 2  STANDBY/ON button (8)  
*Turns the unit on or off (standby mode).*
- 3 CD/RANDOM button (13, 14)  
*Selects CD mode.  
Starts or stops random play in CD mode.*
- 4 DISPLAY MODE button (8, 17)  
*Displays the clock time or sets the timer.*
- 5 TIMER ON/OFF SET button (17)  
*Activates/deactivates the timer.*
- 6 Remote sensor (5)  
*Infrared sensor for remote control*
- 7 PROGRAM button (8, 10, 13, 17)  
*CD: programs the track playback order.  
Tuner: presets radio stations.  
Clock/Timer: sets the clock/timer.*
- 8 REPEAT button (14)  
*CD: repeats a track or the whole disc.*  
PRESET  /  buttons (10)  
*Tuner: Selects a preset radio station.*
- 9 PHONES jack (8)  
*Connect the headphones to this jack.*
- 10 Tape deck (15)
- 11 REC  (Recording) button (16)  
*Switches to record ready state.*
- 12 TUNER/BAND button (10)  
*Selects tuner mode.  
Selects FM or MW in tuner mode.*
- 13 TAPE button (15)  
*Selects tape mode.*
- 14  OPEN/CLOSE button (13)  
*Opens/closes the disc compartment.*
- 15 REMAIN/RDS MODE button (12, 14)  
*CD: displays the remaining time of a track/disc or elapsed time of a disc during playback.  
Tuner (FM): displays RDS information.*
- 16 INTRO/RDS SEARCH button (12, 14)  
*CD: starts or stops introductory play.  
Tuner (FM): selects RDS search.*
- 17 VOLUME +/- buttons (8)  
*Adjust the volume.*
- 18 PRE EQ/HBS button (9)  
*Selects the desired sound mode.  
Switches on or off the HBS system.*
- 19  EJECT (15)  
*Opens the tape deck door.*
- 20 SEARCH/TUNING  /  buttons (8, 10, 13, 15, 17)  
*CD: search backward/forward or skip to the beginning of the current/previous/next track.  
Tuner: tune to a lower or higher radio frequency or search radio stations.  
Tape: rewind or fast forward.  
Clock/Timer: set the hour and minute.*

- 21 PLAY/PAUSE  /  button (13, 15)  
*CD/Tape: starts or interrupts playback.  
STOP/CLEAR  button (13, 15)  
CD: stops playback or clears the program.  
Tape: stops playback or recording.*

## Display window

- 1  / ON/OFF (timer on/off) indicators (17)
- 2 HBS indicator (9)
- 3 SLEEP indicator (18)
- 4 PROGRAM indicator (10, 13)
- 5 RDS indicator (12)
- 6 Main display
- 7 Sound mode indicators (9)  
POP, CLASSIC, ROCK, JAZZ
- 8  (play mode) indicator (13, 15)
- 9 TOTAL/REMAIN indicators (14)
- 10 RANDOM indicator (14)
- 11 INTRO indicator (14)
- 12 STEREO indicator (10)
- 13 REPEAT ONE/ALL indicators (14)
- 14 CD SYNC (synchronous recording) indicator (16)
- 15 MHz/kHz (frequency) indicators (10)
- 16 REC /  (recording/pause) indicators (16)
- 17 TAPE indicator (15)

## Remote Control

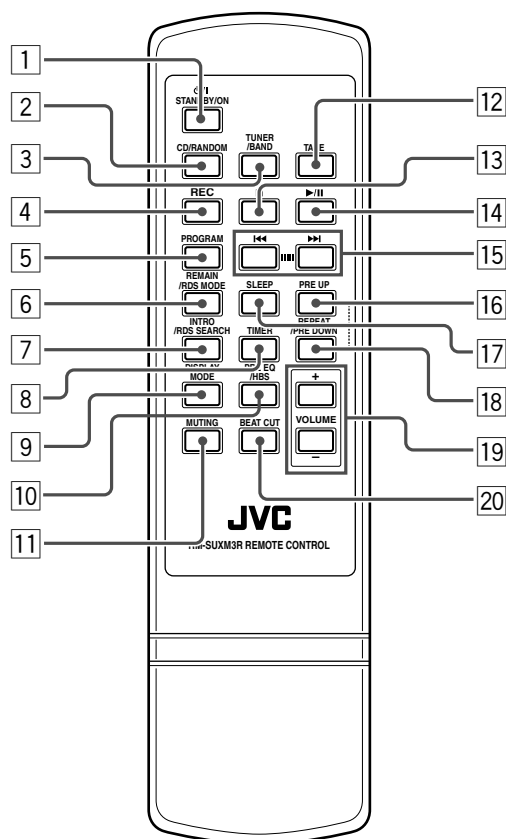

## Remote Control

- 1 STANDBY/ON button
- 2 CD/RANDOM button
- 3 TUNER/BAND button
- 4 REC (Recording) button
- 5 PROGRAM button
- 6 REMAIN/RDS MODE button
- 7 INTRO/RDS SEARCH button
- 8 TIMER button
- 9 DISPLAY MODE button
- 10 PRE EQ/HBS button
- 11 MUTING button  
*Interrupts and resumes sound reproduction.*
- 12 TAPE button
- 13 button
- 14 button
- 15 buttons
- 16 PRE UP button
- 17 SLEEP button  
*Selects the time length until the unit is turned off.*
- 18 REPEAT/PRE DOWN button
- 19 VOLUME +/- buttons
- 20 BEAT CUT button  
*Eliminates beats during MW broadcast recording.*

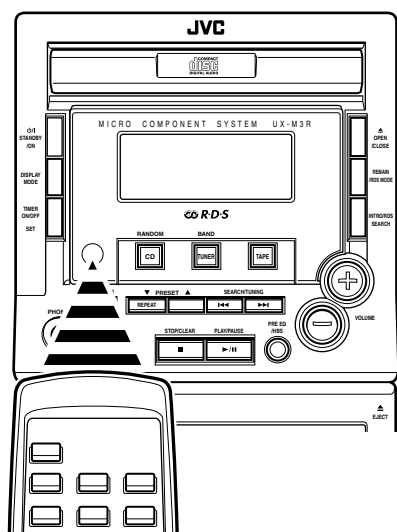

When using the remote control, point it at the remote sensor on the front panel.



## Unpacking

After unpacking, check to be sure that you have all the following items.

The number in the parentheses following each item name indicates the supplied quantity.

- Remote control (1)
- Batteries (R03 (UM-4)/AAA (24F)) for remote control (2)
- AM loop antenna (1)

If any is missing, consult your dealer immediately.

## Putting the Batteries into the Remote Control

Insert 2 batteries — R03 (UM-4)/AAA (24F) — into the battery compartment of the remote control, complying with the + and – polarity markings inside the battery compartment. When the remote control can no longer operate the unit, replace both batteries at the same time.

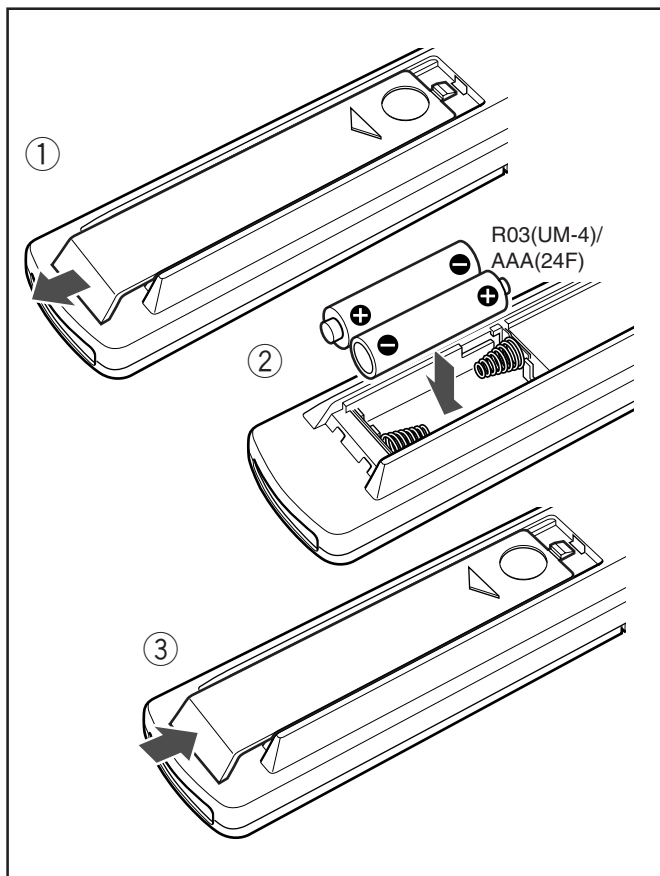

- DO NOT use an old battery together with a new one.
- DO NOT use different types of batteries together.
- DO NOT expose batteries to heat or flame.
- DO NOT leave the batteries in the battery compartment when you are not going to use the remote control for an extended period of time; otherwise, the remote control may be damaged by battery leakage.

## Connections



- DO NOT connect any equipment to the unit while the unit is powered.
- DO NOT plug in any equipment until all connections are completed.

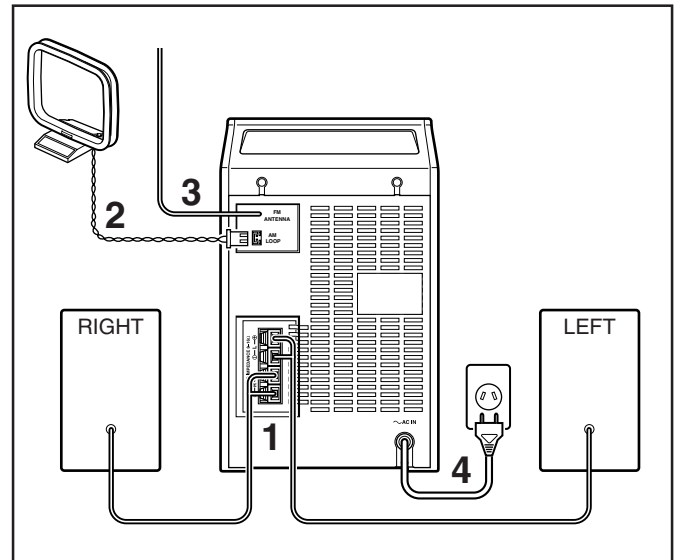

### 1 Connect the speakers.

Connect the right speaker to the “R” terminals, with the red wire to + and the black wire to –.

Connect the left speaker to the “L” terminals in the same way.

Clip the stripped portion of each speaker wire as shown in the illustration.

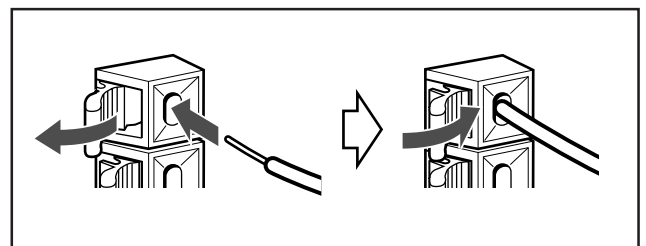

---

**2 Connect the supplied AM loop antenna to the AM LOOP terminal.**

Place the antenna away from the unit and adjust its position for the best reception.

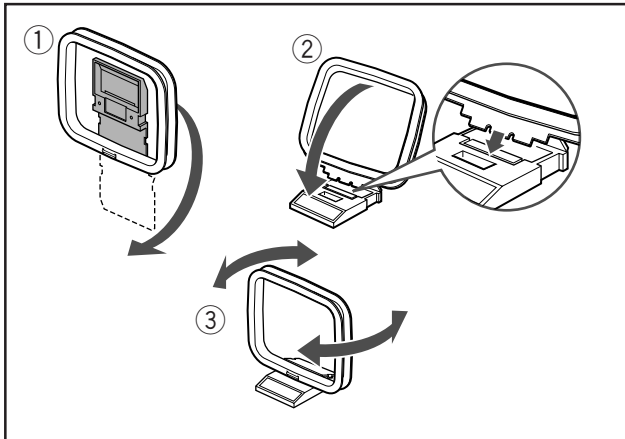

**3 Adjust the position of the FM antenna for the best reception.**

**4 Connect the AC power cord of the unit to the AC outlet after all other connections have been made.**

## Turning On or Off the Unit

### To turn on the unit

Press  STANDBY/ON on the unit or remote control.

The unit turns on with the last source selection remaining valid.

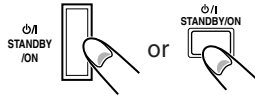

### To turn off the unit (on standby)

Press  STANDBY/ON on the unit or remote control. The clock time appears if the clock is already set.

## Setting the Clock

Before operating the unit any further, first set the built-in clock.

### 1 When the unit is in standby mode, press and hold PROGRAM until the hour indication starts blinking.



- When the unit is on, press DISPLAY MODE to enter clock mode, then press and hold PROGRAM.

### 2 Press or to set the hour, then press PROGRAM.

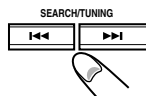

The minute indication starts blinking.

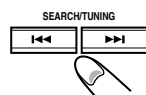

### 3 Press or to set the minute, then press PROGRAM to store the setting.

The clock starts working.



To change the hour or minute indication rapidly in steps 2 and 3, press and hold  or .

### To select 12-hour or 24-hour display mode

In standby mode, hold down  and press PROGRAM repeatedly.

With each press, the selection toggles between 12-hour and 24-hour modes.

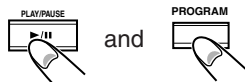

- In 12-hour mode, “AM 12:00” indicates midnight and “PM 12:00” indicates noon.

### To check the clock time while the unit is on

Press DISPLAY MODE.

The clock time is displayed until you press any key.



### To correct the clock time

Carry out steps 1 to 3 above.



### On clock resetting

If a power failure occurs or the AC power cord is disconnected, the clock is reset to "0:00" (flashing). In such a case you need to set the clock again.

## Adjusting the Volume

- You can adjust the volume only while the unit is turned on.

### Press VOLUME + or VOLUME – to increase or decrease the volume level.



The volume can be adjusted in 41 steps between “VOL MIN” (minimum) and “VOL MAX” (maximum).

To increase or decrease the volume level rapidly, press and hold VOLUME + or VOLUME –.

### To turn off the sound temporarily

Press MUTING on the remote control. Playback continues without sound and the muting indicator appears on the display.



To restore the sound, press MUTING again or increase or decrease the volume level.



### For private listening

Connect a pair of headphones to the PHONES jack. No sound comes out of the speakers. Be sure to turn down the volume before connecting or putting on headphones.



DO NOT turn off the unit (on standby) with the volume set to an extremely high level; otherwise, a sudden blast of sound can damage your hearing and/or the speakers when you turn on the unit or start playing any source next time.

---

## Digital Sound Control

---

The unit's digital sound control feature enables you to select desired preset equalizer settings (selectable as sound modes) to enjoy special sound effects matching the music type. You can also use the HBS (Hyper Bass Sound) system to enjoy powerful bass sound created by emphasizing low frequencies.

### To select the desired sound mode

Press PRE EQ/HBS repeatedly.



Each time you press the button, the sound mode changes as follows:

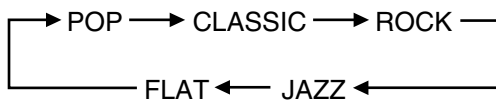

- POP: More presence in the vocals and midrange
- CLASSIC: Enriched sound with fine treble and ample bass
- ROCK: Powerful sound emphasizing treble and bass
- JAZZ: Accented lower frequencies for jazz-type music
- FLAT: Equalizer effect is canceled.

### To switch the HBS system on/off

Press and hold PRE EQ/HBS until "HBS ON" or "HBS OFF" appears on the display.



When the HBS system is switched on, the HBS indicator lights up on the display.

## Tuning In a Station

- 1 When the unit is turned on, press TUNER/BAND to select tuner mode.**

The unit tunes in the last station tuned in (either FM or MW).



- 2 Press TUNER/BAND to select the band, FM or MW.**

Each time you press the button, the band selection alternates between FM and MW.



- 3 Press and hold |◀◀ or ▶▶| for more than 1 second.**

The unit starts searching for stations and stops when a station of sufficient signal strength is tuned in.

If a program is broadcast in stereo, the STEREO indicator lights up.

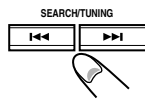

To stop searching, press |◀◀ or ▶▶|.



When you press |◀◀ or ▶▶| briefly and repeatedly the frequency changes step by step.

## Presetting Stations

You can preset 20 FM and 20 MW stations.

- There is a time limit in doing the following steps. If the setting is canceled before you finish, start from step 1 again.

- 1 Tune in the station you want to preset.**

- See “Tuning In a Station” on the left.

- 2 Press PROGRAM.**

The PROGRAM indicator and “00” start blinking on the display.



- 3 Press PRESET ▼ or ▲ (or PRE UP or REPEAT/PRE DOWN on the remote control) to specify the desired preset number.**

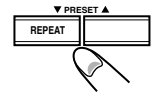

- 4 Wait a few seconds to confirm the preset number.**

- Alternatively, press PROGRAM.

- 5 To preset more stations, repeat the steps above, allocating a different preset number to each station.**



### When a new station is stored

The station previously memorized with the same preset number is erased. (The frequency of the new station replaces the previous frequency in memory.)

---

## Tuning In a Preset Station

---

1 Press TUNER/BAND to select tuner mode.



2 Press TUNER/BAND to select the band, FM or MW.

3 Press PRESET ▼ or ▲ (or PRE UP or REPEAT/PRE DOWN on the remote control) to select the desired preset number.

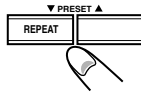

# Receiving FM Stations with RDS

RDS (Radio Data System) allows FM stations to send an additional signal along with their regular program signals. For example, the stations send their station names, as well as information about what type of program they broadcast, such as sports or music, etc.

When tuned to an FM station which provides the RDS service, the RDS indicator lights up on the display. With the unit, you can receive the following types of RDS signals.

## PS (Program Service):

Shows commonly known station names.

## PTY (Program Type):

Shows types of broadcast programs.

## RT (Radio Text):

Shows text messages the station sends.



### More about RDS

- Some FM stations do not provide RDS signals.
- RDS services vary among FM RDS stations. For details on RDS services in your area, check with local radio stations.
- RDS may not work correctly if the received station is not transmitting the signals properly or if the signal strength is weak.

## Changing the RDS Information

You can see RDS information on the display while listening to an FM station.

### Press REMAIN/RDS MODE.

Each time you press the button, the display changes to show the following information:

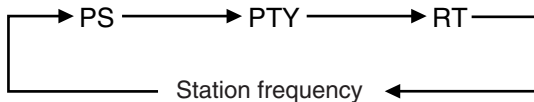

- If no PS, PTY, or RT signals are sent by a station, “NO PS”, “NO PTY”, or “NO TEXT” appears on the display.



### On the characters displayed

When the display shows PS, PTY or RT signals:

- The display shows upper case letters only.
- The display cannot show accented letters; For example, “A” may represent accented “A’s” like “Á, Â, Ã, Ä, Å and Æ”.

## Searching for Programs by PTY Codes (PTY Search)

One of the advantages of RDS is that you can locate a particular kind of program by specifying the PTY (Program Type) codes.

- For details on each of the PTY codes, see “Description of the PTY Codes” on page 19.
- There is a time limit in doing the following steps. If the setting is canceled before you finish, start from step 1 again.

### 1 Press INTRO/RDS SEARCH until the PTY code you want appears on the display.



Each time you press the button, the PTY codes change as follows:



### 2 Press ◀◀ or ▶▶.



The unit searches FM stations, stops when it finds the one you have selected, and tunes in that station.

- If no program is found, the unit returns to the last received station.

To stop searching during the process, press INTRO/RDS SEARCH.

# Playing Back CDs

This unit can play back audio CDs.



## Loading a Disc

**1 Press CD/RANDOM to select CD mode.**



**2 Press ▲ OPEN/CLOSE.**  
The disc tray slides out.



**3 Load a disc with the label side facing up.**

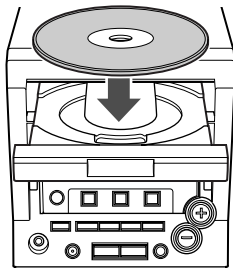

**4 Press ▲ OPEN/CLOSE to close the disc compartment.**

The total number of tracks and the playing time of the disc appear on the display.



## Basic CD Operations

**1 Press ►/|| to start playback.**

The ► indicator lights up and the track number and elapsed playing time of the current track appear on the display.



**2 To stop playback, press ■.**



### To interrupt playback

Press ►/||.

The ► indicator and the playing time starts blinking.



**To resume playback, press ►/|| again.**

### To select a desired track

Press ◀◀ or ▶▶ repeatedly until the desired track appears on the display.

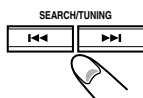

### To search for a particular point during playback

Press and hold ◀◀ or ▶▶ to locate the desired point.



## Program Play

You can arrange the order in which the tracks are played before you start playing. You can program up to 60 tracks.

**1 In stop mode, press PROGRAM.**

The PROGRAM indicator starts blinking.



**2 Press ◀◀ or ▶▶ repeatedly to select the desired track.**

The current program number starts blinking.



**3 Press PROGRAM to store the selected track.**

“00” and the next program number appear on the display.



**4 Repeat steps 2 and 3 to store other tracks.**

- You cannot program more than 60 tracks. If you attempt to do it, “FULL” will flash on the display.

### To review the programmed sequence

Press PROGRAM repeatedly in stop mode. The program number and track number are displayed in succession.



### To modify the program

Press PROGRAM repeatedly to select the program number with which you want to change the track, then repeat steps 2 and 3 above.



### To play the programmed tracks

Press ►/||.



- During program play, you can press ◀◀ or ▶▶ to select the desired track in the program.



### If you press REPEAT during program play

The current track or all programmed tracks are played repeatedly.

### To clear the program

Press ■ in stop mode. The PROGRAM indicator disappears from the display.



- The stored program is cleared when the CD compartment is opened.



---

## Random Play

---

You can play all the tracks in random order.

### Press CD/RANDOM before or during playing.

The RANDOM indicator lights up.



To exit random play mode, press CD/RANDOM again. The RANDOM indicator goes off.

- Activating the REPEAT ONE function during random play mode disables the random play mode.
- It is not possible to activate the random play function during program play mode.

---

## Repeat Play

---

You can play the current track or the whole disc repeatedly.

### Press REPEAT repeatedly to select either of the following repeat play modes:

REPEAT ONE: repeats the current track.  
REPEAT ALL: repeats the whole disc.



The current track or the whole disc is played repeatedly until you press ■.

To exit repeat play mode, press REPEAT repeatedly so that the REPEAT indicator disappears from the display.

- Activating the random play function during REPEAT ONE play mode disables the repeat play mode.

---

## Introductory Play

---

The introductory portions of tracks can be played back automatically.

### Press INTRO/RDS SEARCH.

The first 10-second portion of each of the tracks is played back in order.



To exit introductory play mode, press INTRO/RDS SEARCH again.

- The introductory play function is also available during program play mode, random play mode and repeat play mode.

---

## Displaying the Remaining Time during Playback

---

You can display the remaining time of the current track/disc and the elapsed time of the current track/disc during playing a CD.

### Press REMAIN/RDS MODE repeatedly to select one of the following time display modes:

REMAIN: shows the remaining time of the current track.  
TOTAL REMAIN: shows the remaining time of the disc.  
TOTAL: shows the elapsed time of the disc.  
No indication: shows the elapsed time of the current track.



# Playing Back Tapes

- Use only type I normal tapes.



The use of tapes longer than 120 minutes is not recommended, since characteristic deterioration may occur and these tapes easily jam in the pinchroller and the capstan.

## Loading a Tape

- 1 Press **EJECT** to open the tape deck door.

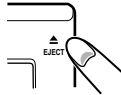

- 2 Insert a recorded tape with the open side down and playback side facing out from the unit.

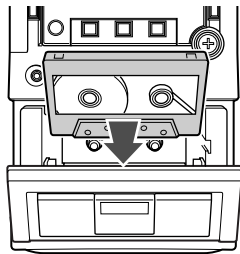

- 3 Close the tape deck door.

The TAPE indicator appears on the display.

## Tape Playback

- 1 When the unit is turned on, press **TAPE**.



- 2 Press **▶/II**.

Playback starts.  
“PLAY” and the ▶ indicator appear on the display.



- 3 To stop playback, press **■**.



### To interrupt playback

Press **▶/II**.

The ▶ indicator starts blinking and “PAUSE” appears on the display.



To resume playback, press **▶/II** again.

## Rewind/Fast Forward

- 1 Press **◀◀** or **▶▶** to rewind or fast forward the tape.

“REW” or “FF” appears on the display.



- 2 Press **■** to stop rewinding or fast forwarding.



- The tape stops automatically at the end of the rewinding or fast forwarding.

# Recording

## IMPORTANT:

- It may be unlawful to record or playback copyrighted material without the consent of the copyright owner.
- The recording level is automatically set correctly, so it is not affected by the volume control. Thus, during recording you can adjust the sound you are actually listening to without affecting the recording level.
- While recording, you can hear sound modes and/or the HBS sound effect through the speakers. However, the sound is recorded without these effects (see page 9).
- If recordings you have made have excessive noise or static, the unit may be too close to a TV. Increase the distance between the TV and the unit.
- Use only type I normal tapes for recording.
- The use of tapes longer than 120 minutes is not recommended, since characteristic deterioration may occur and these tapes easily jam in the pinchroller and the capstan.

## To protect your recording

Cassettes have two small tabs on the back to prevent unexpected erasure or re-recording.

To protect your recording, remove these tabs.

To re-record on a protected tape, cover the holes with adhesive tape.

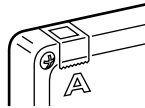

## Recording Tapes

### 1 Load a recordable tape into the tape deck.

Insert a tape with the open side down and the side to be recorded facing out from the unit.

### 2 Press CD/RANDOM or TUNER/BAND to select the desired recording source.

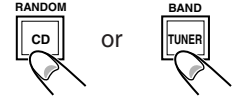

### 3 Prepare the source.

#### • For synchronous recording of a CD

Load the disc (see page 13).

- To start recording from the desired track, select the track by pressing ◀◀ or ▶▶ repeatedly in stop mode.
- To start recording from the desired point on a disc, play the disc and pause at the desired point by pressing ▶/||.

#### • For recording from the radio

Tune in the desired station (see page 10).

### 4 Press REC.

“REC” is displayed. The TAPE REC indicator and “II” light up and the recording direction indicator starts blinking.



### 5 Press ▶/|| for recording.

Recording starts.

“II” goes off. The TAPE REC indicator remains on the display.

When recording a CD, the CD SYNC indicator also lights up.



### To stop recording, press ■.

The selected recording source continues playing.

- During recording, it is not possible to pause or listen to another source. “REC ON” appears on the display.
- Recording continues to the end of the tape until you press ■ even after playback of the CD has finished.

## Using the BEAT CUT function

When recording an MW broadcast, beats may occur. If this happens, press BEAT CUT on the remote control to select the better beat-cut position, “BEAT 01” or “BEAT 02”.

# Using the Timers

There are three timers available – daily timer, recording timer and sleep timer.

Before using the timers, you need to set the built-in clock. (See page 8.)

## Using Daily Timer

With the daily timer, you can wake to your favorite music or radio program.

### How the daily timer actually works

At the timer-on time, the unit automatically turns on, sets the volume to the preset level, and starts playing the specified source (radio or CD). Then, at the timer-off time, the unit automatically turns off (on standby).

The timer setting remains in memory until you change it.

- There is a time limit in doing the following steps. If the setting is canceled before you finish, start from step 1 again.

- 1 Press and hold DISPLAY MODE until “⌚ ON” starts blinking on the display, then press PROGRAM.**

The hour indication starts blinking.

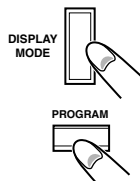

- 2 Press |◀◀ or ▶▶| to set the timer start hour, then press PROGRAM.**

The minute indication starts blinking.

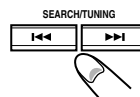

- 3 Press |◀◀ or ▶▶| to set the minute, then press PROGRAM.**

“⌚ ON” starts blinking again.



- 4 Press DISPLAY MODE so that “⌚ OFF” starts blinking on the display, then press PROGRAM.**

The hour indication starts blinking.

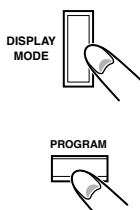

- 5 Set the time to stop playback following the same procedure as steps 2 and 3.**

- 6 Press DISPLAY MODE so that “TUNER,” “TAPE,” “CD” or “REC TU” appears on the display, then press PROGRAM.**

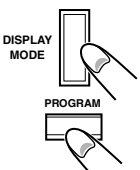

- 7 Press |◀◀ or ▶▶| to select the desired source, then press PROGRAM.**

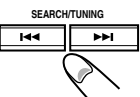

- 8 Prepare the source and set the volume.**

To listen to the radio, tune in the desired station.

To listen to a CD, load the disc.

- 9 Press TIMER ON/OFF SET (or TIMER on the remote control) to activate the timer.**

“⌚” lights up on the display.



- 10 Turn off the unit (on standby).**

When the preset time is reached, the selected source is played if the timer has been activated.

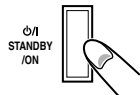

**To deactivate the timer,** press TIMER ON/OFF SET (or TIMER on the remote control).

“⌚” disappears from the display.

- The timer-off function is not activated if the starting and stopping times are the same.
- If the selected source (CD or TAPE) is not available when preset timer is reached, TUNER is selected automatically.

## Timer Recording

You can use the recording timer to record a preset radio station from a specified time and for a specified duration automatically.

- 1 Load a recordable tape into the tape deck.**  
Insert a tape with the open side down and the side to be recorded facing out from the unit.
- 2 Follow the “Using Daily Timer” procedure on the left. Select “REC TU” as the source for timer recording.**

- If the preset time is reached while the unit is on, the timer is not activated for timer recording.
- The recording timer is canceled once the recording is finished.

---

## Using Sleep Timer

---

With the sleep timer, you can fall asleep to music. You can set the sleep timer using the remote control when the unit is turned on.

### How the sleep timer actually works

The unit automatically turns off after the specified time length passes.

**1 Press and hold SLEEP on the remote control until the desired time length appears on the display.**



The time length changes from 90 to 10 minutes in 10-minute steps.

**2 Wait for a moment after specifying the time length.**

The SLEEP indicator lights up steadily on the display.

- Setting both the timer-off and sleep-off times causes the unit to enter standby mode when the earlier one of them is reached.

**To change the shut-off time**, repeat the procedure above.

**To cancel the setting**, press SLEEP so that the SLEEP indicator goes off.

- The sleep timer is also canceled when you turn off the unit.

# Description of the PTY Codes

<b>NEWS:</b>	News.
<b>AFFAIRS:</b>	Topical program expanding or enlarging upon the news – debate, or analysis.
<b>INFO:</b>	Program the purpose of which is to impart advice in the widest sense.
<b>SPORT:</b>	Program concerned with any aspect of sports.
<b>EDUCATE:</b>	Educational programs.
<b>DRAMA:</b>	All radio plays and serials.
<b>CULTURE:</b>	Programs concerning any aspect of national or regional culture, including language, theater, etc.
<b>SCIENCE:</b>	Programs about natural sciences and technology.
<b>VARIED:</b>	Used for mainly speech-based programs such as quizzes, panel games and personality interviews.

<b>POP M:</b>	Commercial music of current popular appeal.
<b>ROCK M:</b>	Rock music.
<b>MOR M:</b>	Easy-listening music of relatively short duration.
<b>LIGHT M:</b>	Instrumental music, and vocal or choral works.
<b>CLASSICS:</b>	Performances of major orchestral works, symphonies, chamber music, etc.
<b>OTHER M:</b>	Music not fitting into any of the other categories.

**Classification of the PTY codes for some FM stations may be different from the above list.**

## Troubleshooting

If you are having a problem with your unit, check this list for a possible solution before calling for service. If you cannot solve the problem from the hints given here, or the unit has been physically damaged, call a qualified person, such as your dealer, for service.

Symptom	Cause	Action
No sound is heard.	<ul style="list-style-type: none"> <li>• Connections are incorrect or loose.</li> <li>• Headphones are connected.</li> </ul>	<ul style="list-style-type: none"> <li>• Check all connections and make corrections. (See pages 6 and 7.)</li> <li>• Disconnect the headphones.</li> </ul>
Hard to listen to broadcasts because of noise.	<ul style="list-style-type: none"> <li>• Antennas are disconnected.</li> <li>• The AM loop antenna is too close to the unit.</li> <li>• The FM antenna is not properly extended and positioned.</li> </ul>	<ul style="list-style-type: none"> <li>• Reconnect the antennas correctly and securely.</li> <li>• Change the position and direction of the AM loop antenna.</li> <li>• Extend the FM antenna at the best position.</li> </ul>
The disc tray does not open or close.	The AC power cord is not plugged in.	Plug the AC power cord.
The disc does not play.	The disc is placed upside down.	Place the disc with the label side up.
The disc sound is discontinuous.	The disc is scratched or dirty.	Clean or replace the disc. (See page 20.)
The cassette holder cannot be opened.	Power supply from the AC power cord has been cut off while the tape was running.	Turn on the unit.
Impossible to record.	Small tabs on the back of the cassette are removed.	Cover the holes with adhesive tape.
Operations are disabled.	The built-in microprocessor may malfunction due to external electrical interference.	Unplug the AC power cord and then plug it back in.
Unable to operate the unit from the remote control.	<ul style="list-style-type: none"> <li>• The path between the remote control and the remote sensor on the unit is blocked.</li> <li>• The batteries are exhausted.</li> </ul>	<ul style="list-style-type: none"> <li>• Remove the obstruction.</li> <li>• Replace the batteries.</li> </ul>

# Maintenance

To get the best performance of the unit, keep your discs, tapes, and mechanism clean.

## Handling discs



- Remove the disc from its case by holding it at the edge while pressing the center hole lightly.
- Do not touch the shiny surface of the disc, or bend the disc.
- Put the disc back in its case after use to prevent warping.

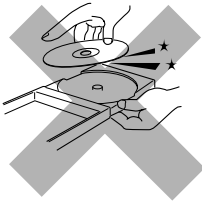

- Be careful not to scratch the surface of the disc when placing it back in its case.
- Avoid exposure to direct sunlight, temperature extremes, and moisture.



### To clean the disc

Wipe the disc with a soft cloth in a straight line from center to edge.



DO NOT use any solvent — such as conventional record cleaner, spray, thinner, or benzine — to clean the disc.

## Handling cassette tapes



- If the tape is loose in its cassette, take up the slack by inserting a pencil in one of the reels and rotating.
- If the tape is loose, it may get stretched, cut, or caught in the cassette.



- Be careful not to touch the tape surface.



- Avoid the following places to store the tape:
  - In dusty places
  - In direct sunlight or heat
  - In moist areas
  - Near a magnet

## Cassette decks

If the heads, capstan, and pinch roller of the cassette deck become dirty, the following will occur:

- Impaired sound quality
- Discontinuous sound
- Fading
- Incomplete erasure
- Difficulty in recording

### To clean the heads, capstan, and pinch roller

Use a cotton swab moistened with alcohol.

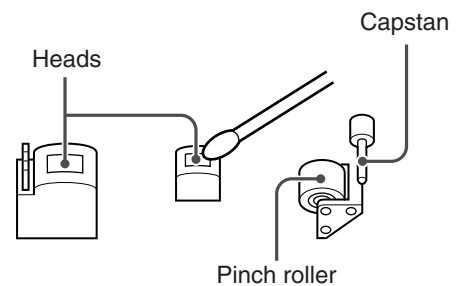

### To demagnetize the heads

Turn off the unit, and use a head demagnetizer (available at electronics and record shops).

## Cleaning the unit

### • Stains on the unit

Should be wiped off with a soft cloth. If the unit is heavily stained, wipe it with a cloth soaked in water diluted neutral detergent and wrung well, then wipe clean with a dry cloth.

### • Since the unit may deteriorate in quality, become damaged or get its paint peeled off, be careful about the followings.

- DO NOT wipe it with a hand cloth
- DO NOT wipe it strong
- DO NOT wipe it with thinner or benzine.
- DO NOT apply any volatile substance such as insecticides to it.
- DO NOT allow any rubber or plastic to remain in contact with it for a long time.

# Specifications

---

## Amplifier section

Output power  
24 W (12 W + 12 W) at 8  $\Omega$  (MAX.)  
20 W (10 W + 10 W) at 8  $\Omega$  (10% THD)

Audio output level  
PHONES: 800 mV/32  $\Omega$

Speakers/Impedance 8  $\Omega$  - 16  $\Omega$

## Tuner

FM tuning range 87.50 MHz - 108.00 MHz  
MW tuning range 522 kHz - 1 629 kHz

## CD player

Dynamic range 60 dB  
Signal-to-noise ratio 60 dB  
Wow and flutter Unmeasurable

## Cassette deck

Frequency response  
Normal (type I): 100 Hz - 10 000 Hz  
Wow and flutter 0.35% (WRMS)

## General

Power requirement AC 240 V  $\sim$ , 50 Hz  
Power consumption 30 W (operation mode)  
1.5 W (standby mode)  
Dimensions 160 mm  $\times$  269.5 mm  $\times$  300 mm  
(W/H/D)  
Mass 4.3 kg

## Speaker

Speaker unit Woofer: 10.2 cm cone  $\times$  1  
Tweeter: 5.1 cm cone  $\times$  1  
Impedance 8  $\Omega$   
Dimensions 160 mm  $\times$  269.5 mm  $\times$  192 mm  
(W/H/D)  
Mass 2 kg/each

## Supplied accessories

See page 6.

*Design and specifications are subject to change without notice.*

# JVC

VICTOR COMPANY OF JAPAN, LIMITED